

NHG180332Series

Slip rings of the NHG180332 series are specially fit for high temperature 100°C~250°C working environment such as hot roller, heating device. Grand applies noble precious metal reduced noises and interference between circuits, low friction torque assures long life-span.

NHG180332 series with through hole 180mm, OD332mm, suitable for rotating application which requires a through hole ≤ 180 mm, Standard model supports 1-48 power rings(0-20A/ring) or 1-96 signal rings(0~5A/ring)

Features

- ◆ Multi-point brush contact material ensure long life
- ◆ Integrated structure design for easy installation
- ◆ Standard model supports 1-96rings power or signal(0~20A/ring)
- ◆ IP 51 (IP54-IP68 can be customized)
- ◆ Both the data bus agreement compatible
- ◆ Free maintenance

Typical application

- ◆ Automatic machines
- ◆ Robotics, rotary sensors, urgent illumination equipment
- ◆ Roller
- ◆ Packaging
- ◆ Heating device
- ◆ Medical, Pharmaceutical equipment
- ◆ Converting machines
- ◆ Capping machines
- ◆ Labeling machines
- ◆ Filling machine
- ◆ Machine tools

Options

- ◆ Optional for underwater IP65, IP68 Operation speed, current & voltage
- ◆ No. of rings
- ◆ Connector
- ◆ Housing material
- ◆ Position of wire outlet, wire length
- ◆ Protection level (dust and water)
- ◆ Flange mounting is optional
- ◆ Operating temperature
- ◆ Support mixed high speed data transmission(including Ethernet, USB, Profibus, Ethercat, CANOPEN, CANBUS, RS232, RS485, etc.)
- ◆ Fluidic rotary joints, FORJ and electric slip ring can be mixed.

Specifications

Electrical Data			Mechanical Data	
	Power	Signal	Max. Speed	0-250 rpm
Rated Current	10~20A/ring	2~5A/ring	Working Temperature	-20°C~+250°C
Rated Voltage	0~380VAC/VDC	0~240VAC/VDC	Working Humidity	0-85% RH
Insulation Resistance	≥500MΩ/500VDC	≥500MΩ/500VDC	Structure Material	Engineering plastic or metal
Dielectric Strength	500VAC@50Hz,60s	500VAC@50Hz,60s	Contact material	Precious metal
Wire Size	Sliver plated Teflon AWG16(10A), AWG14(20A)	Sliver plated Teflon AWG26(2A), AWG22(5A)	Operating Torque	0.1N·m for 6 rings, 0.03 N·m increased for every 6 rings added
Wire Length	Standard 500mm(adjustable)			
Dynamic Resistance	<0.01Ω		Protection level	IP51

Product Code

For standard versions	NHG XXX XXX – XP/XS –XXX
	1 2 3 4 5 6
1	High temperature slip ring
2	Inner dimension of housing ; Eg, XXX= 100, the ID is 100mm
3	Outer dimension of housing; Eg, XXX= 203, the OD is 203mm
4	Number of power rings; Eg, XP= 3P, the number of power rings is 3, P=10A, P1=15A, P2=20A
5	Number of signal circuits; Eg, XS= 2S, the number of signal rings is 2
6	Customer special options

Lead Wires Color Code

Ring#	1	2	3	4	5	6	7	8	9	10	11	12
Color	RED	YEL	BLK	BLU	GRN	WHT	PUP	GRY	BRN	ORN	DBLU	KHK

Drawing for Outline Dimension

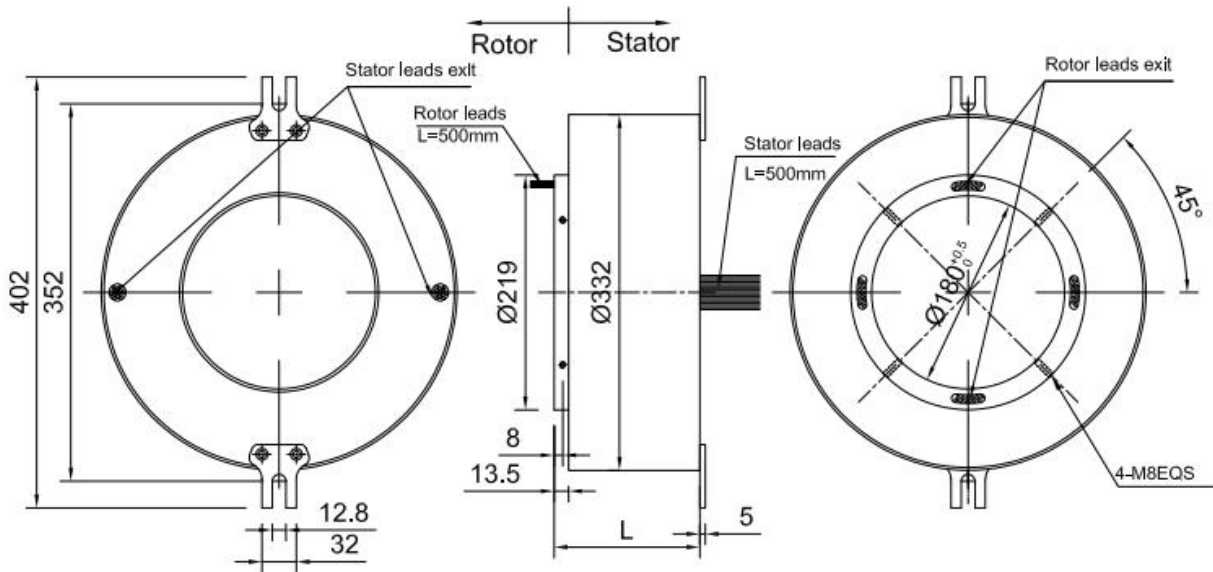

Model List

Model	Power Ring (10A/15A/20A)	Signal Ring(5A)	Length (mm)
NHG180332-6P	6	-	142
NHG180332-12S	-	12	142
NHG180332-12P	12	-	190
NHG180332-6P/12S	6	12	190
NHG180332-24S	-	24	190
NHG180332-18P	18	-	238
NHG180332-12P/12S	12	12	238
NHG180332-6P/24S	6	24	238
NHG180332-36S	-	36	238
NHG180332-24P	24	-	286
NHG180332-18P/12S	18	12	286
NHG180332-12P/24S	12	24	286
NHG180332-6P/36S	6	36	286
NHG180332-48S	-	48	286
NHG180332-30P	30	-	328
NHG180332-24P/12S	24	12	328
NHG180332-18P/24S	18	24	328
NHG180332-12P/36S	12	36	328
NHG180332-6P/48S	6	48	328
NHG180332-60S	-	60	328

NHG180332-36P	36	-	370
NHG180332-30P/12S	30	12	370
NHG180332-24P/24S	24	24	370
NHG180332-18P/36S	18	36	370
NHG180332-12P/48S	12	48	370
NHG180332-6P/60S	6	60	370
NHG180332-72S	-	72	370
NHG180332-42P	42	-	412
NHG180332-36P/12S	36	12	412
NHG180332-30P/24S	30	24	412
NHG180332-24P/36S	24	36	412
NHG180332-18P/48S	18	48	412
NHG180332-12P/60S	12	60	412
NHG180332-6P/72S	6	72	412
NHG180332-84S	-	84	412
NHG180332-48P	48	-	454
NHG180332-42P/12S	42	12	454
NHG180332-36P/24S	36	24	454
NHG180332-30P/36S	30	36	454
NHG180332-24P/48S	24	48	454
NHG180332-18P/60S	18	60	454
NHG180332-12P/72S	12	72	454
NHG180332-6P/84S	6	84	454
NHG180332-96S	-	96	454